



INSTALLATION MANUAL

Split System air conditioners

FHA35AVEB99
FHA50AVEB99
FHA60AVEB99
FHA71AVEB99
FHA100AVEB9
FHA125AVEB9
FHA140AVEB9

Ceiling-mounted unit ^(a)	
m (kg)	A _{min} (m ²)
≤1.842	—
1.843	3.64
2.0	3.95
2.2	4.34
2.4	4.74
2.6	5.13
2.8	5.53
3.0	5.92
3.2	6.48
3.4	7.32
3.6	8.20
3.8	9.14
4.0	10.1
4.2	11.2
4.4	12.3
4.6	13.4
4.8	14.6
5.0	15.8
5.2	17.1
5.4	18.5
5.6	19.9
5.8	21.3
6.0	22.8
6.2	24.3
6.4	25.9
6.6	27.6
6.8	29.3
7.0	31.0
7.2	32.8
7.4	34.7
7.6	36.6
7.8	38.5
7.956	40.1

Wall-mounted unit ^(b)	
m (kg)	A _{min} (m ²)
≤1.842	—
1.843	4.45
2.0	4.83
2.2	5.31
2.4	5.79
2.6	6.39
2.8	7.41
3.0	8.51
3.2	9.68
3.4	10.9
3.6	12.3
3.8	13.7
4.0	15.1
4.2	16.7
4.4	18.3
4.6	20.0
4.8	21.8
5.0	23.6
5.2	25.6
5.4	27.6
5.6	29.7
5.8	31.8
6.0	34.0
6.2	36.4
6.4	38.7
6.6	41.2
6.8	43.7
7.0	46.3
7.2	49.0
7.4	51.8
7.6	54.6
7.8	57.5
7.956	59.9

Floor-standing unit ^(c)	
m (kg)	A _{min} (m ²)
≤1.842	—
1.843	28.9
2.0	34.0
2.2	41.2
2.4	49.0
2.6	57.5
2.8	66.7
3.0	76.6
3.2	87.2
3.4	98.4
3.6	110
3.8	123
4.0	136
4.2	150
4.4	165
4.6	180
4.8	196
5.0	213
5.2	230
5.4	248
5.6	267
5.8	286
6.0	306
6.2	327
6.4	349
6.6	371
6.8	394
7.0	417
7.2	441
7.4	466
7.6	492
7.8	518
7.956	539

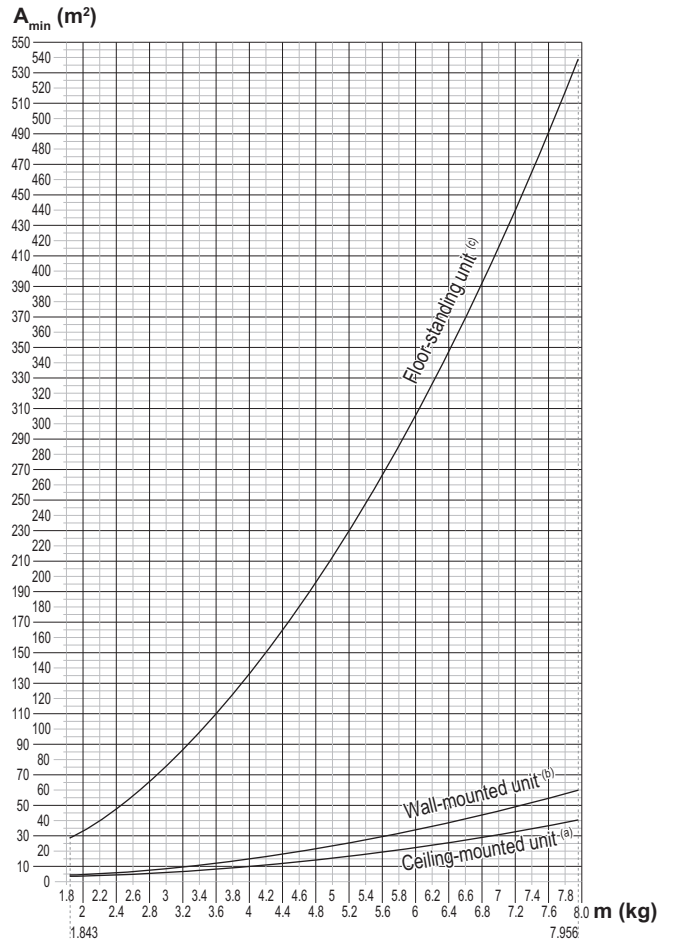

UKCA – Safety declaration of conformity

Daikin Europe N.V.

declares under its sole responsibility that the products to which this declaration relates:

FHA35AVEB99, FHA50AVEB99, FHA60AVEB99, FHA71AVEB99, FHA100AVEB9, FHA125AVEB9, FHA140AVEB9,

are in conformity with the following directive(s) or regulation(s), provided that the products are used in accordance with our instructions:

- S.I. 2008/1597: Supply of Machinery (Safety) Regulations 2008**
- S.I. 2016/1101: Electrical Equipment (Safety) Regulations 2016
- S.I. 2016/1091: Electromagnetic Compatibility Regulations 2016*

as amended,

following the provisions of: BS EN 60335-2-40,

* as set out in <A> and judged positively by according to the **Certificate <C>**.

<A>	DAIKIN.TCF.033A14/02-2019
	—
<C>	—



** Daikin Europe N.V. is authorised to compile the Technical Construction File.



CONTENTS

1. SAFETY PRECAUTIONS..... 1
 2. BEFORE INSTALLATION..... 2
 3. SELECTION OF INSTALLATION LOCATION 3
 4. PREPARATION BEFORE INSTALLATION 5
 5. INSTALLATION OF THE INDOOR UNIT..... 6
 6. REFRIGERANT PIPING WORK 7
 7. DRAIN PIPING WORK..... 9
 8. ELECTRIC WIRING WORK11
 9. HOW TO CONNECT WIRINGS
 AND WIRING EXAMPLE.....11
 10. MOUNTING SUCTION GRILLE · DECORATION
 SIDE PANEL..... 15
 11. FIELD SETTING..... 15
 12. TO PERFORM A TEST RUN..... 16
 13. UNIFIED WIRING DIAGRAM LEGEND 18

The original instructions are written in English.
 All other languages are translations of the original instructions.

Symbol	Explanation
	Before installation, read the installation and operation manual, and the wiring instruction sheet.
	Before performing maintenance and service tasks, read the service manual.
	For more information, see the installer and user reference guide.

	This appliance is filled with R32.*
---	-------------------------------------

* Only applicable if this appliance is connected with the following models of outdoor units: RZAG35~140, RZASG71~140, RXM35~60, 3MXM40~68, 4MXM68~80, 5MXM90

1. SAFETY PRECAUTIONS

Carefully read these instructions before installation. Keep this manual in a handy place for future reference.
 Be sure to follow this "SAFETY PRECAUTIONS".
 This product comes under the term "appliances not accessible to the general public".

- This manual classifies the precautions into WARNINGS and CAUTIONS.
 Be sure to follow all the precautions below: They are all important for ensuring safety.

 **WARNING**Indicates a potentially hazardous situation which, if not avoided, could result in death or serious injury.

 **CAUTION**Indicates a potentially hazardous situation which, if not avoided, may result in minor or moderate injury.
 It may also be used to alert against unsafe practices.

- After the installation is completed, test the air conditioner and check if the air conditioner operates properly. Give the user

adequate instructions concerning the use and cleaning of the indoor unit according to the Operation Manual. Ask the user to keep this manual and the Operation Manual together in a handy place for future reference.

⚠ WARNING

- Make sure installation, testing and applied materials comply with applicable legislation (on top of the instructions described in the Daikin documentation).
- The appliance shall be stored in a room without continuously operating ignition sources (example: open flames, an operating gas appliance or an operating electric heater).
- Ask your local dealer or qualified personnel to carry out installation work.
 Improper installation may result in water leakage, electric shocks or a fire.
- Perform installation work in accordance with this installation manual.
 Improper installation may result in water leakage, electric shocks or a fire. Consult your dealer regarding what to do in case of refrigerant leakage.
 When the air conditioner is installed in a small room, it is necessary to take proper measures so that the amount of any leaked refrigerant does not exceed the concentration limit in the event of a leakage.
 Otherwise, this may lead to an accident due to oxygen deficiency.
- Be sure to use only the specified parts and accessories for installation work.
 Failure to use the specified parts may result in the air conditioner falling down, water leakage, electric shocks, a fire, etc.
- Install the air conditioner on a foundation that can withstand its mass.
 Insufficient strength may result in the air conditioner falling down and causing injury.
 In addition, it may lead to vibration of indoor units and cause unpleasant chattering noise.
- Carry out the specified installation work in consideration of strong winds, typhoons, or earthquakes.
 Improper installation may result in an accident such as air conditioner falling.
- Make certain that all electrical work is carried out by qualified personnel according to the applicable legislation (note 1) and this installation manual, using a separate circuit.
 In addition, even if the wiring is short, make sure to use a wiring that has sufficient length and never connect additional wiring to make the length sufficient.
 Insufficient capacity of the power supply circuit or improper electrical construction may lead to electric shocks or a fire.
 (note 1) applicable legislation means "All international, national and local directives, laws, regulations and/or codes which are relevant and applicable for a certain product or domain".
- Earth the air conditioner.
 Do not connect the earth wiring to gas or water piping, lightning conductor or telephone earth wiring.
 Incomplete earthing may cause electric shocks or a fire.
- Be sure to install an earth leakage breaker.
 Failure to do so may cause electric shocks and a fire.
- Disconnect the power supply before touching the electric components.
 If you touch the live part, you may get an electric shocks.
- Make sure that all wiring is secure, using the specified wirings and ensuring that external forces do not act on the terminal connections or wirings.
 Incomplete connection or fixing may cause an overheat or a fire.

- When wiring between the indoor and outdoor units, and wiring the power supply, form the wirings orderly so that the control box cover can be securely fastened.
If the control box cover is not in place, overheat of the terminals, electric shocks or a fire may be caused.
- If the supply cord is damaged, it must be replaced by the manufacturer, a service agent or similarly qualified persons in order to avoid a hazard.
- If refrigerant gas leaks during installation work, ventilate the area immediately.
Toxic gas may be produced if refrigerant gas comes into contact with a fire.
- After completing the installation work, check to make sure that there is no leakage of refrigerant gas.
Toxic gas may be produced if refrigerant gas leaks into the room and comes into contact with a source of a fire, such as a fan heater, stove or cooker.
- Never directly touch any accidental leaking refrigerant. This could result in severe wounds caused by frostbite.

Instructions for equipment using R32 refrigerant

- Do NOT pierce or burn.
- Do NOT use means to accelerate the defrosting process or to clean the equipment, other than those recommended by the manufacturer.
- Be aware that R32 refrigerant does NOT contain an odour.
- The appliance shall be stored so as to prevent mechanical damage and in a well-ventilated room without continuously operating ignition sources (example: open flames, an operating gas appliance or an operating electric heater) and have a room size as specified in "SELECTION OF INSTALLATION LOCATION" on page 3.

CAUTION

- Install drain piping according to this installation manual to ensure good drainage, and insulate the piping to prevent condensation.
Improper drain piping may cause water leakage, make the furniture get wet.
- Install the air conditioner, power supply wiring, remote controller wiring and transmission wiring at least 1 meter away from televisions or radios to prevent image interference or noise.
(Depending on the radio waves, a distance of 1 meter may not be sufficient to eliminate the noise.)
- Install the indoor unit as far as possible from fluorescent lamps.
If a wireless remote controller kit is installed, the transmission distance may be shorter in a room where an electronic lighting type (inverter or rapid start type) fluorescent lamp is installed.
- Do not install the air conditioner in places such as the following:
 1. Where there is mist of oil, oil spray or vapour for example a kitchen.
Resin parts may deteriorate, and cause them to fall out or water to leak.
 2. Where corrosive gas, such as sulfurous acid gas, is produced.
Corrosion of copper pipings or brazed parts may cause the refrigerant to leak.
 3. Where there is machinery which emits electromagnetic waves.
Electromagnetic waves may disturb the control system, and cause malfunction of the equipment.

4. Where flammable gases may leak, where carbon fibre or ignitable dust is suspended in the air or where volatile flammables, such as thinner or gasoline, are handled.
If the gas should leak and remained around the air conditioner, it may cause ignition.
- The air conditioner is not intended for use in a potentially explosive atmosphere.
 - Only use accessories, optional equipment and spare parts made or approved by Daikin.
 - Make sure the installation site withstands the unit's weight and vibration.
 - Use an all-pole disconnection type breaker with at least 3 mm between the contact point gaps that provide full disconnection under overvoltage category III.





2. BEFORE INSTALLATION







When unpacking and moving the indoor unit after unpacked, do not apply force to the piping (refrigerant and drain) and resin parts.

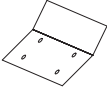

- If appliances are connected to the outdoor unit which contain R32 refrigerant. Required floor area of the room in which appliances are installed, operated and stored must follow requirements in the installation manual of outdoor unit.
- Make sure to check in advance that the refrigerant to be used for installation work is according to the Outdoor Unit specification.
(The air conditioner will not properly operate if a wrong refrigerant is used.)
- For installation of the outdoor unit, refer to the installation manual attached to the outdoor unit.
- Do not throw away the accessories until the installation work is completed.
- After the indoor unit is carried into the room, to avoid the indoor unit from getting damaged, take measures to protect the indoor unit with packing materials.
 - (1) Determine the route to carry the unit into the room.
 - (2) Do not unpack the unit until it is carried to the installation location.
Where unpacking is unavoidable, use a sling of soft material or protective plates together with a rope when lifting, to avoid damage or scratches to the indoor units.
- Have the customer actually operate the air conditioner while looking at the manual.
Instruct the customer how to operate the air conditioner (particularly cleaning of the air filters, operation procedures, and temperature adjustment).
- For selection of installation location, use the installation pattern paper (used in common with the packing case.) as reference.
- Do not use the air conditioner where in the salty atmosphere such as coastal areas, vehicles, vessels or the voltage fluctuation is frequent such as factories.
- Take off static electricity from the body when carrying out wiring and the control box cover is removed.
The electric parts may be damaged.

2-1 ACCESSORIES

Check if the following accessories are attached to the indoor unit.

Name	(1) Drain hose	(2) Metal clamp	(3) Washer for hanger	(4) Clamp
Quantity	1 pc.	1 pc.	8 pcs.	7 pcs.
Shape				

Name	(5) Installation pattern paper	Joint insulating material	Sealing material	(10) Resin bushing
Quantity	1 sheet	1 each	1 each	1 pc.
Shape		(6) For gas piping  (7) For liquid piping 	(8) Large  (9) Small 	

Name	(11) Wiring fixture	(12) Screw for wiring fixture	(Miscellaneous)
Quantity	2 pcs.	2 pcs.	• Operation manual • Installation manual • Declaration of conformity
Shape		M4 × 12 	

2-2 OPTIONAL ACCESSORIES

- For this indoor unit, the remote controller is separately required.
- There are 2 kinds of remote controller; wired type and wireless type.
Install the remote controller to the place where the customer has given consent.
Refer to the catalog for the applicable model.
(Refer to the installation manual attached to the remote controller for how to install.)

CARRY OUT THE WORK GIVING CAUTION TO THE FOLLOWING ITEMS AND AFTER THE WORK IS COMPLETED CHECK THESE AGAIN.

1. Items to be checked after the installation work is completed

Items to be checked	In case of defective	Check column
Are the indoor and outdoor units rigidly fixed?	Drop · vibration · noise	
Are the installation work of the outdoor and indoor units complete?	Does not operate · burnout	
Have you carried out a leakage test with the test pressure specified in the outdoor unit installation manual?	Does not cool / Does not heat	
Is the insulation of refrigerant piping and drain piping completely carried out?	Water leakage	
Does the drain flow out smoothly?	Water leakage	
Is the power supply voltage identical to that stated in the manufacturer's label on the air conditioner?	Does not operate · burnout	
Are you sure that there is no wrong wiring or piping or no loose wiring?	Does not operate · burnout	
Is earthing completed?	Danger in case of leakage	

Are the sizes of electric wiring according to the specification?	Does not operate · burnout	
Is any of air outlets or inlets of the indoor and outdoor units blocked with obstacles?	Does not cool / Does not heat (It may lead to capacity drop due to fan speed drop or malfunction of equipment.)	
Have you recorded the refrigerant piping length and the refrigerant charge added?	Refrigerant charge amount is not clear	

*Make sure to recheck the items of "SAFETY PRECAUTIONS"

2. Items to be checked at delivery

Items to be checked	Check column
Have you carried out field setting? (if necessary)	
Are the control box cover, the air filter and the suction grille attached?	
Does the cool air discharge during the cooling operation and the warm air discharge during heating operation comes out of the unit?	
Have you explained how to operate the air conditioner showing the operation manual to the customer?	
Have you explained the description of cooling, heating, program dry and automatic (cooling/heating) given in the operation manual to the customer?	
If you set the fan speed at thermostat OFF, did you explain the set fan speed to the customer?	
Have you handed the operation manual and the installation manual to the customer?	

3. Points of the operation explanation

In addition to the general usage, since the items in the operation manual with the \triangle WARNING and \triangle CAUTION marks are likely to result in human bodily injuries and property damages, it is necessary not only to explain these items to the customer but also to have the customer read them.
It is also necessary to explain the items of "NOT MALFUNCTION OF THE AIR CONDITIONER" to the customer and have the customer read them carefully.

3. SELECTION OF INSTALLATION LOCATION

Make sure the area is well ventilated. Do NOT block any ventilation openings.

When unpacking and moving the indoor unit after unpacked, do not apply force to the piping (refrigerant and drain) and resin parts.

- (1) Select the installation location that meets the following conditions and get approval of the customer.
 - Where the cool and warm air spreads evenly in the room.
 - Where there is no obstacles in the air passage.
 - Where drainage can be ensured.
 - Where the ceiling lower surface is not inclined.

- Where there is sufficient strength to withstand the mass of the indoor unit (if the strength is insufficient, the indoor unit may vibrate and get in contact with the ceiling and generate unpleasant chattering noise).
- Where a space sufficient for installation and service can be ensured. (Refer to Fig. 1 and Fig. 2)
- Where the piping length between the indoor and the outdoor units is ensured within the allowable length. (Refer to the installation manual attached to the outdoor unit.)
- Where there is no risk of flammable gas leak.

To determine the minimum floor area (only for R32 refrigerant)

- Use the graph or table to determine the minimum floor area. See figure 1 on the inside of the front cover.

m Total refrigerant charge in the system

A_{min} Minimum floor area

- (a) Ceiling-mounted unit (= Ceiling-mounted unit)
- (b) Wall-mounted unit (= Wall-mounted unit)
- (c) Floor-standing unit (= Floor-standing unit)

[Required installation space (mm)]

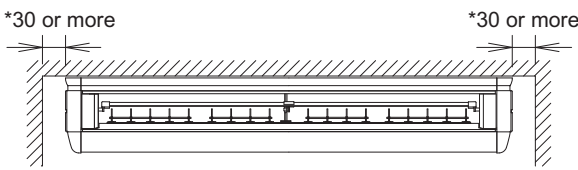

Fig. 1

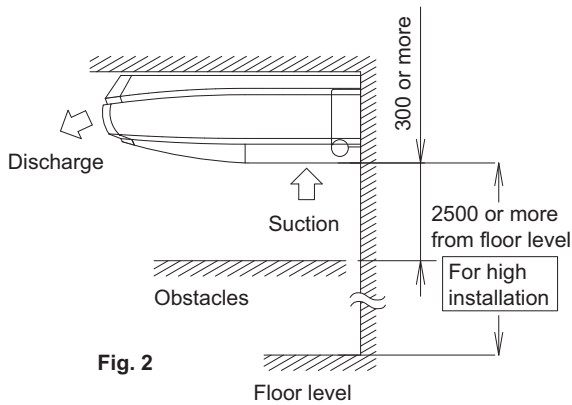

Fig. 2

NOTE

- If there is extra space required for * part, servicing can be conducted more easily if 200mm or more is secured. Install the indoor and outdoor units, power supply wiring, remote controller wiring and transmission wiring at least 1 meter away from televisions or radios to prevent image interference or noise. (Depending on the radio waves, a distance of 1 meter may not be sufficient to eliminate the noise.)
- Install the indoor unit as far as possible from fluorescent lamps. If a wireless remote controller kit is installed, the transmission distance may be shorter in a room where an electronic lighting type (inverter or rapid start type) fluorescent lamp is installed.
- The sound pressure level is less than 70 dBA.

(2) Use hanging bolts for installation.

Investigate if the installation place can withstand the mass of the indoor unit and, if necessary, hang the indoor unit with bolts after it is reinforced by beams etc. (Refer to the installation pattern paper for the mounting pitch.)

(3) Ceiling height

This indoor unit can be installed up to 4.3m for 100~140 class and up to 3.5m for 35~71 class.

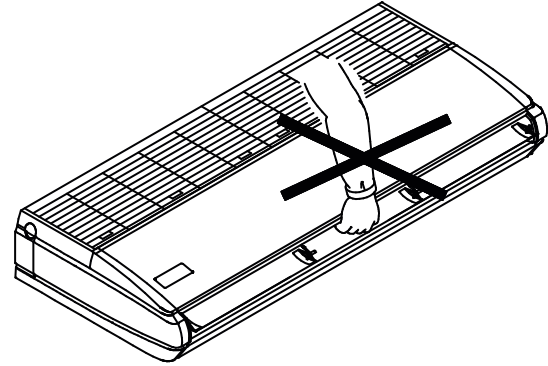

- Please do not take out the product giving a lot of care to the resin side panel and discharge horizontal blade and the air outlet.

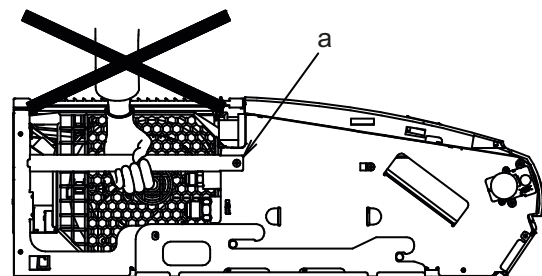
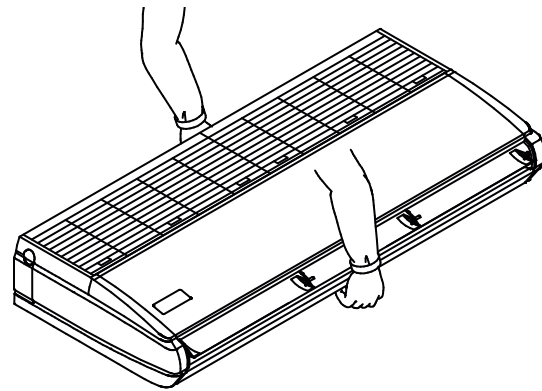

a reinforced plate

- Please do not lift the product and do not pull it with the reinforced plate (right and left). When the reinforced plate bends, it might cause noise.

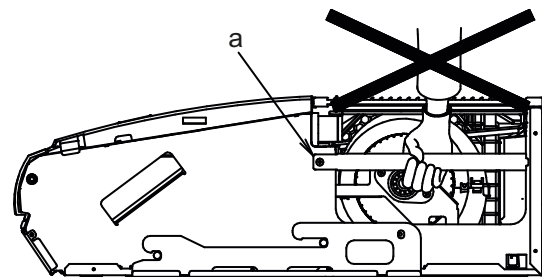

a reinforced plate

4. PREPARATION BEFORE INSTALLATION or the locations of indoor unit hanging bolts, piping outlet holes, drain piping outlet hole, and electric wiring inlet hole. (Refer to Fig. 3)

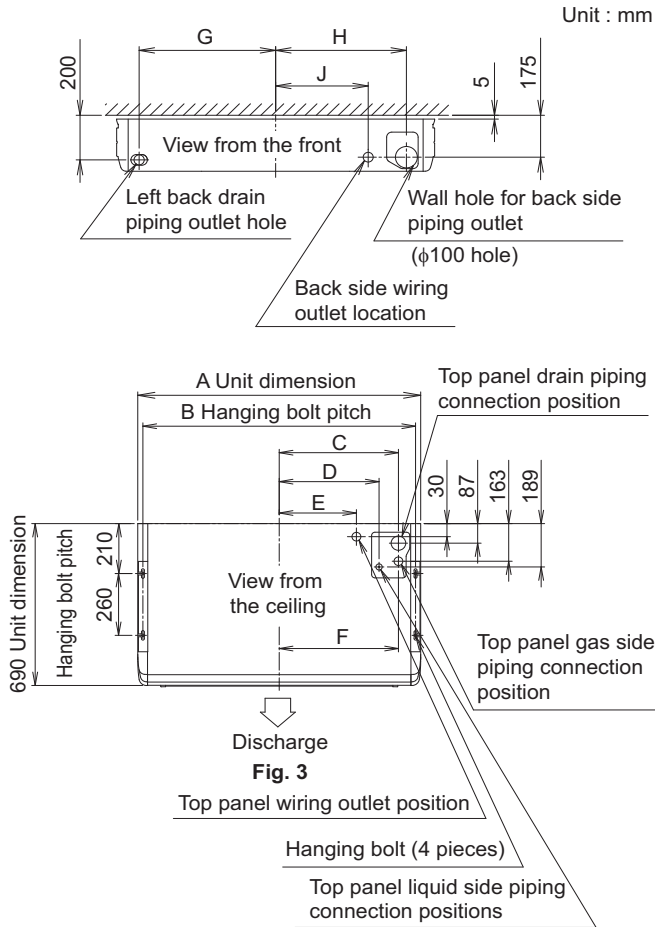

Model name (FHA)	A	B	C	D	E	F	G	H	J
Class 35/50	960	920	378	324	270	375	398	377	260
Class 60/71	1270	1230	533	479	425	530	553	532	415
Class 100/125/140	1590	1550	693	639	585	690	713	692	575

(4) Make holes for hanging bolts, piping outlet, drain piping outlet, and electric wiring inlet.

- Use the installation pattern paper (5).
- Determine the locations of hanging bolts, piping outlet, drain piping outlet and electric wiring inlet. And make the hole.

• How to use the pattern see the picture below.

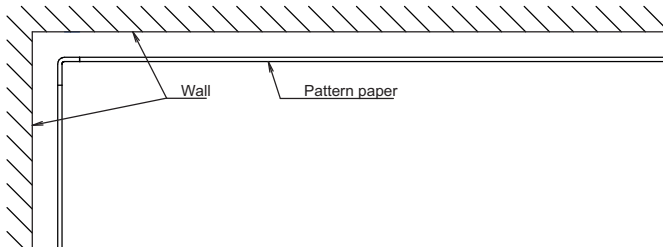

(5) Remove the parts of the indoor unit.

1) Remove the suction grille.

- Slide the suction grille fixing knobs (35, 50 class: 2 places for each, 60~140 class: 3 places for each) toward backward direction (as shown by an arrow) to open the suction grille widely. (Refer to Fig. 4)

- Keeping the suction grille opened, hold the knob at the back of the suction grille and at the same time, pull the suction grille forward to remove. (Refer to Fig. 5)

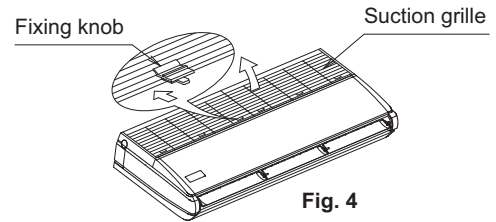

Fig. 4

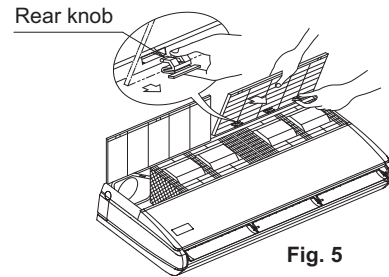

Fig. 5

2) Remove the decoration side panel (right, left).

- Remove the fixture screw of the decoration side panel (one for each), pull forward (arrow direction) to remove. (Refer to Fig. 6)
- Take out accessories. (Refer to Fig. 6)
- Open the knock hole at the wiring inlet side at the rear surface or top surface, and install the attached resin bushing (10).

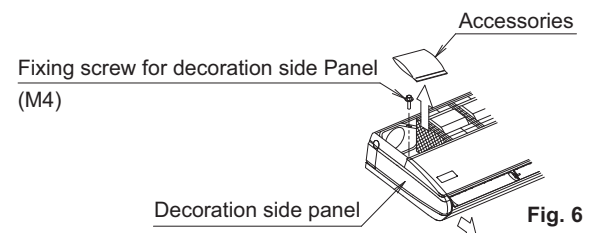
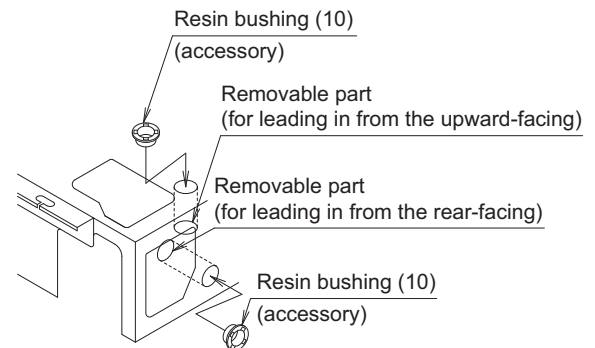

Fig. 6

3) Remove the hanger.

- Loosen 2 bolts for installing the hanger at both sides (M8) (4 places at left and right) within 10mm. (Refer to Fig. 7 and Fig. 8)
- Remove the fixture screw for hanger at the back side (M5), pull the hanger backward (the arrow direction) to remove. (Refer to Fig. 8)

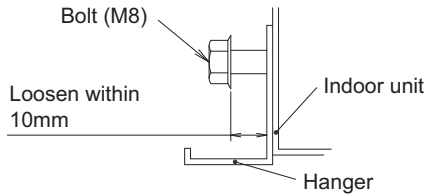

Fig. 7

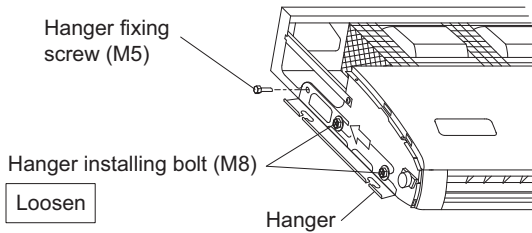
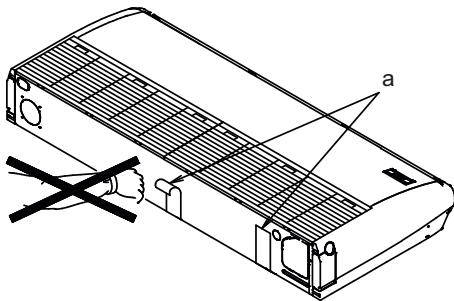

Fig. 8

CAUTION

Do not remove the tape (milky white) applied to the outside of the indoor unit. It may cause electric shocks or a fire.



a tape

(6) Install the hanging bolts.

- Use M8 or M10 bolts for hanging the indoor unit.
- Adjust the length of the hanging bolt from the ceiling in advance. (Refer to Fig. 9)
- Use hole-in-anchors for the existing bolts and embedded inserts or foundation bolts for new bolts, and fix the unit firmly to the building so that it may withstand the mass of the unit. In addition, adjust the distance from the ceiling in advance.

CAUTION

If the hanging bolt is too long, it may damage or break the indoor unit or options.

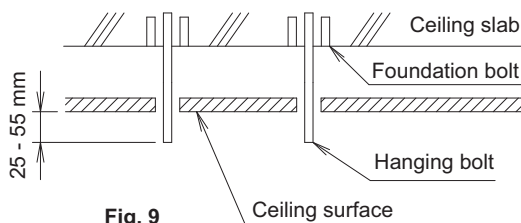

Fig. 9

NOTE

- Parts shown Fig. 9 will be all field supply.

5. INSTALLATION OF THE INDOOR UNIT

It is easy to attach the optional parts before installing the indoor unit. Refer to also the installation manual attached to the optional parts.

For installation, use the attached installation parts and specified parts.

- (1) Fix the hanger to the hanging bolt. (Refer to Fig. 10)

CAUTION

For safety, make sure to use a washer for hanger (3) (accessory) and fix by double nuts firmly.

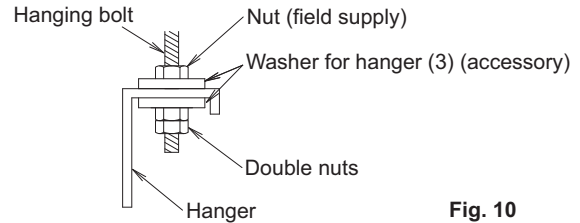

Fig. 10

- (2) Lift up the indoor unit, slide from the front and put the hanger installing bolt (M8) into the securely for temporary hanging. (Refer to Fig. 11)
- (3) Tighten the hanger fixing screws (M5) at 2 places, which were removed, as they were before. (Refer to Fig. 11)
It is necessary to prevent misalignment of the indoor unit.
- (4) Tighten the hanger installing bolts (M8) at 4 places properly. (Refer to Fig. 11)

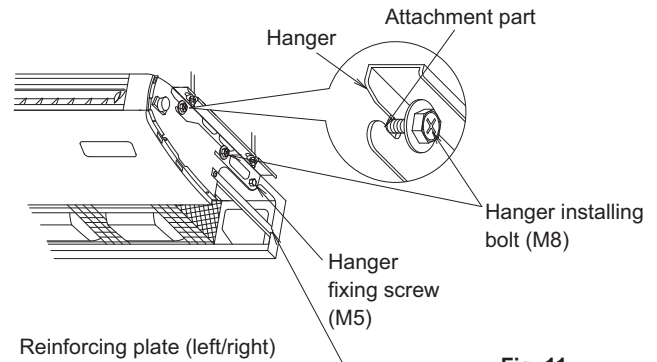

Fig. 11

When carrying the indoor unit, do not hold the reinforcing plates.

- (5) When hanging the indoor unit, make sure to use the level to have better drainage and install it horizontally. Also, if it is possible at the installation site, install so that the drain piping side is slightly lower. (Refer to Fig. 12)

CAUTION

- Setting the indoor unit at an angle opposite to the drain piping might cause a water leakage.
- Do not insert materials other than that specified into the clearance between the hanger and the washer for hanger (3). Unless the washers are properly attached, the hanging bolts may come off from the hanger.

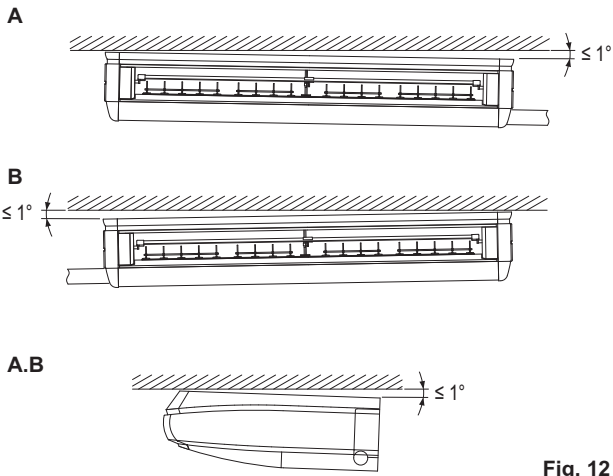

Fig. 12

- A. When the drain piping is tilted to the right, or to the right and back. Place it level, or tilt it slightly to the right or the back. (Within 1°)
- B. When the drain piping is tilted to the left, or to the left and back. Place it level, or tilt it slightly to the left or the back. (Within 1°)

WARNING

The indoor unit must be securely installed on a place that can withstand the mass. If the strength is insufficient, the indoor unit may fall down and cause injuries.

6. REFRIGERANT PIPING WORK

- For the outdoor unit refrigerant piping, refer to the installation manual attached to the outdoor unit.
- Carry out insulation of both gas and liquid refrigerant piping securely. If not insulated, it may cause water leakage. For gas piping, use insulation material of which heat resistant temperature is not less than 120°C. For use under high humidity, strengthen the insulation material for refrigerant piping. If not strengthened, the surface of insulation material may sweat.
- Make sure to check in advance that the refrigerant to be used for installation work is according to the Outdoor Unit specification. (Unless the refrigerant is correct type, the normal operation cannot be expected.)
- Pipework shall be protected from physical damage.
- Installation of pipework shall be kept to a minimum.
- Do NOT re-use joints which have been used already.
- Joints made in installation between parts of refrigerant system shall be accessible for maintenance purposes.
- Refrigerating pipe or components are installed in a position where they are unlikely to be exposed to any substance which may corrode refrigerant containing components, unless the components are constructed of materials which are inherently resistant to being corroded or are suitably protected against being so corroded.
- Make sure to use a recommended bubble test solution from your wholesaler. Do not use soap water, which may cause cracking of flare nuts (soap water may contain salt, which absorbs moisture that will freeze when the piping gets cold), and/or lead to corrosion of flared joints (soap water may contain ammonia which causes a corrosive effect between the brass flare nut and the copper flare).

CAUTION

This air conditioner is a dedicated model for refrigerant R410A or R32. Make sure to meet the requirements shown right and carry out installation work.

- Use dedicated piping cutters and flaring tools according to the used refrigerant type.
- When making a flare connection, coat the flared inner surface only with ether oil or ester oil.
- Use only the flare nuts attached to the air conditioner. If other flare nuts are used, it may cause refrigerant leakage.
- To prevent contamination or moisture from getting into the piping, take measures such as pinching or taping the pipings.

Do not mix substance other than the specified refrigerant such as air into the refrigeration circuit. If the refrigerant leaks during the work, ventilate the room.

- Remove the stay for packing and delivering (reinforcing plate) before refrigerant piping work. (Refer to Fig. 18)
- The refrigerant is pre-charged in the outdoor unit.
- When connecting the pipings to the air conditioner, make sure to use a spanner and a torque wrench as shown in Fig.13. For the dimension of flared part, refer to the Table 1.

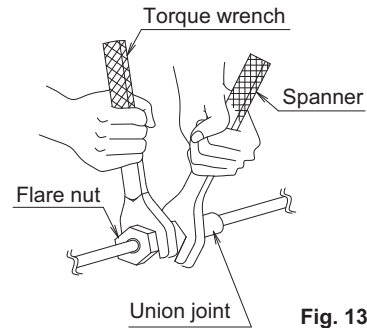

Fig. 13

- When making a flare connection, coat the flared inner surface only with ether oil or ester oil. (Refer to Fig. 14) Then, turn the flare nut 3 to 4 times with your hand and screw in the nut.

Coat the flared inner surface only with ether oil or ester oil.

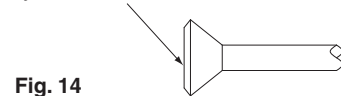

Fig. 14

- For the tightening torque, refer to the Table 1.

Table 1

Piping size (mm)	Tightening torque (N·m)	Dimension for processing flare A (mm)	Flare shape
ø 6.4	15.7 ± 1.5	8.9 ± 0.2	
ø 9.5	36.3 ± 3.6	13.0 ± 0.2	
ø 12.7	54.9 ± 5.4	16.4 ± 0.2	
ø 15.9	68.6 ± 6.8	19.5 ± 0.2	

CAUTION

- Do not have oil adhere to the screw fixing part of resin parts. If oil adheres, it may weaken the strength of screwed part.
- Do not tighten flare nuts too tight. If a flare nut cracks, the refrigerant may leak.

CAUTION

Insulation of field piping must be carried out up to the connection inside the casing. If the piping is exposed to the atmosphere, it may cause sweating or burn due to touching the piping, electric shocks or a fire due to the wiring touching the piping.

- After leak test, referring to Fig. 15, insulate both the gas and liquid piping connection with the attached joint insulating material (6) and (7) to prevent the piping from getting exposed. Then, tighten the both ends of insulating material with the clamp (4).
- Wrap the sealing material (Small) (9) around the joint insulating material (6) (flare nut section), only the gas piping side.
- Make sure to bring the seam of joint insulating material (6) and (7) to the top.

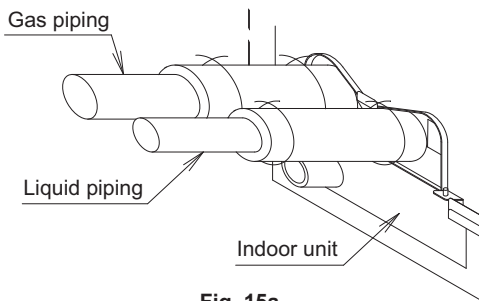

Fig. 15a

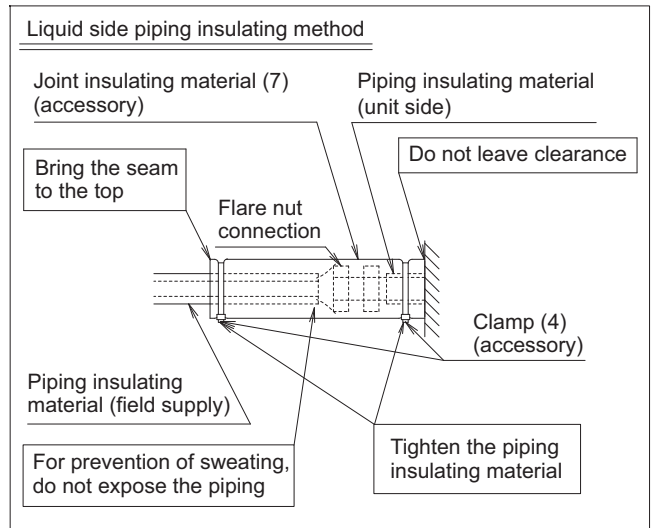

Fig. 15c

- (1) For rear side piping
 - Remove the rear piping penetration cover, and connect the piping. (Refer to Fig. 16 and Fig. 18)
- (2) For upward piping
 - For upward piping, L-shaped connection piping kit (optional accessory) will be required.
 - Remove the top panel penetration cover, and use the L-shaped connection piping kit (optional accessory) to conduct piping. (Refer to Fig. 16 and Fig. 17)
- (3) For right side piping
 - Remove the stay for packing and delivering (reinforcing plate) at the right side, and put back the screw to the original position of the indoor unit. (Refer to Fig. 18)
 - Open the knockout hole at the decoration side panel (right), and connect piping. (Refer to Fig. 18)

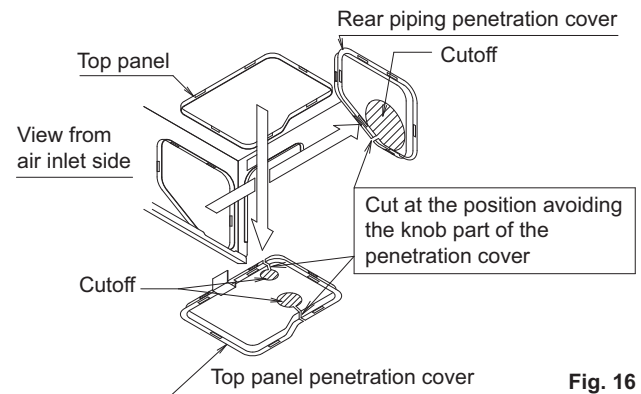

Fig. 16

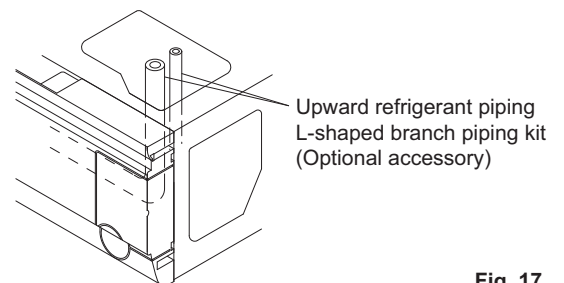

Fig. 17

Gas side piping insulating method

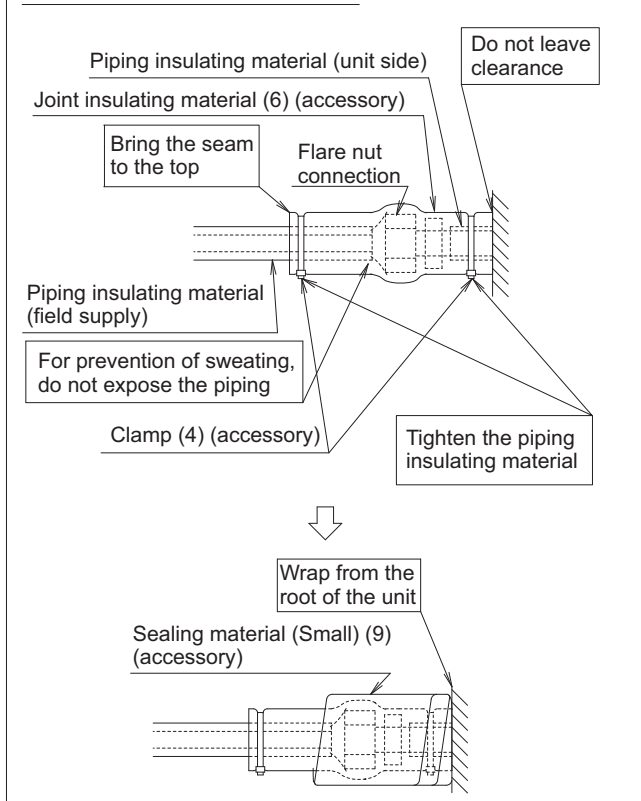

Fig. 15b

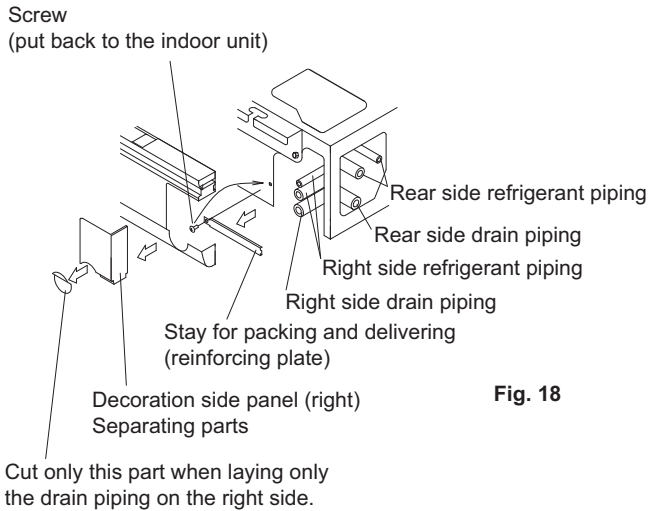

Fig. 18

- After piping is finished, cut the removed penetration cover along the shape of piping, and install it. Also, for top panel penetration cover, as it was before removed, put the horizontal blade motor and thermistor lead through the clamp of the top panel penetration cover and fix. (Refer to Fig. 16 and Fig. 19) When doing this, block any gaps between the piping penetration cover and the piping using putty field supply to prevent dust from entering the indoor unit.

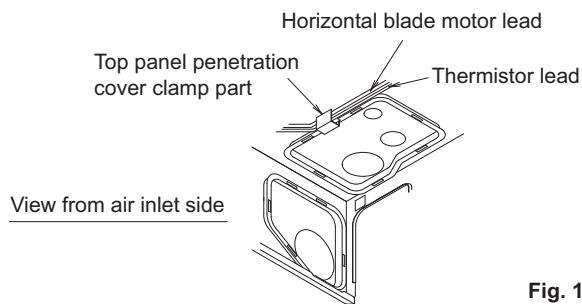

Fig. 19

NOTE

1. When carrying out leakage test of refrigerant piping and the indoor unit after the installation of indoor unit is finished, confirm the connecting outdoor unit installation manual for test pressure. Refer to also the outdoor unit installation manual or technical document for refrigerant piping.
2. In case of refrigerant shortage due to forgetting additional refrigerant charge etc., it will result in malfunction such as does not cool or does not heat. Refer to the outdoor unit installation manual or technical document for refrigerant piping.

7. DRAIN PIPING WORK

(1) Carry out drain piping.

- Carry out drain piping so that drainage is ensured.
- Drain piping can be connected from the following directions: For right rear/right side, refer to Fig. 18 of "6. REFRIGERANT PIPING WORK", and for left rear/left side, refer to Fig. 20.
- When conducting left rear/left side drain piping, remove the protection net. Then, remove the drain socket cap and insulation material applied to left side drain socket and apply them to the right side drain socket. When doing this, insert the drain socket cap all the way in to prevent a water leakage. After the drain hose (1) (accessory) installing, attach the protection net by reversing the steps taken to remove it. (Refer to Fig. 21)

- Select the piping diameter equal to or larger than that of the drain hose (1) (accessory) (polyvinyl chloride piping, nominal diameter 20mm, outside diameter 26mm).
- Install the drain piping as short as possible with downward inclination of 1/100 or more by avoiding air stagnation. (Refer to Fig. 22 and Fig. 23) (It may cause abnormal sound such as bubbling noise.)

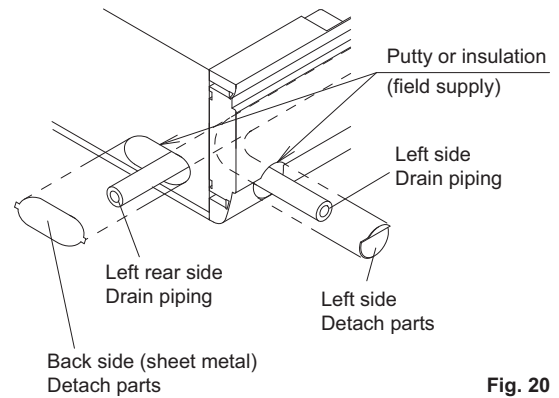

Fig. 20

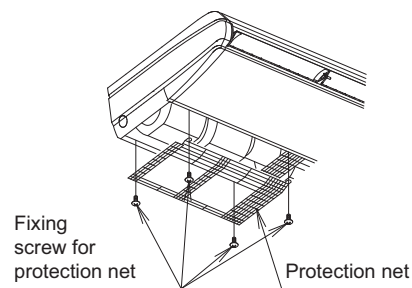

Fig. 21

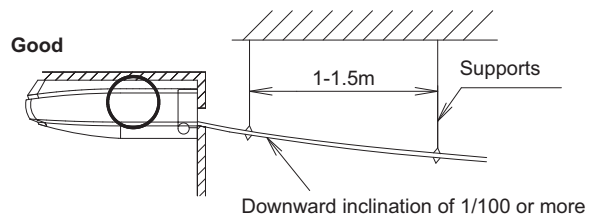

Fig. 22

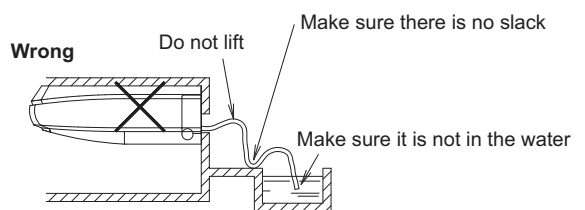

Fig. 23

CAUTION

If drain stagnates in the drain piping, the piping may be clogged.

- Make sure to use the attached drain hose (1) and metal clamp (2). Also, insert the drain hose (1) into the root of the drain socket, and tighten the metal clamp (2) at the root of the drain socket tightly. (Refer to Fig. 24 and Fig. 25) (Install the metal clamp (2) so that the tightening part is in the range of about 45° as shown in the Fig. 25.) (Do not bond the drain socket and drain hose. If so, maintenance and inspection for the heat exchanger and others cannot be conducted.)

CAUTION

If an old drain hose or an elbow or a clamp is used, it may cause water leakage.

- Bend the tip of the metal clamp (2) so that the sealing material does not bulge. (Refer to Fig. 25)
- When performing insulation, wind the large sealing material (Large) (8) attached starting from the base of the metal clamp (2) and drain hose (1) in the direction of the arrow. (Refer to Fig. 24 and Fig. 25)

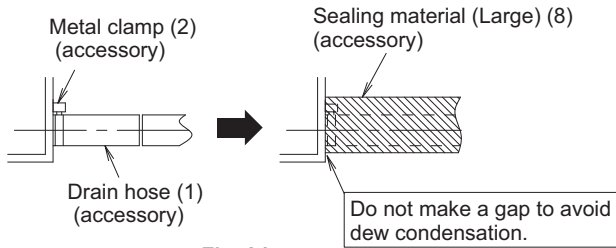

Fig. 24

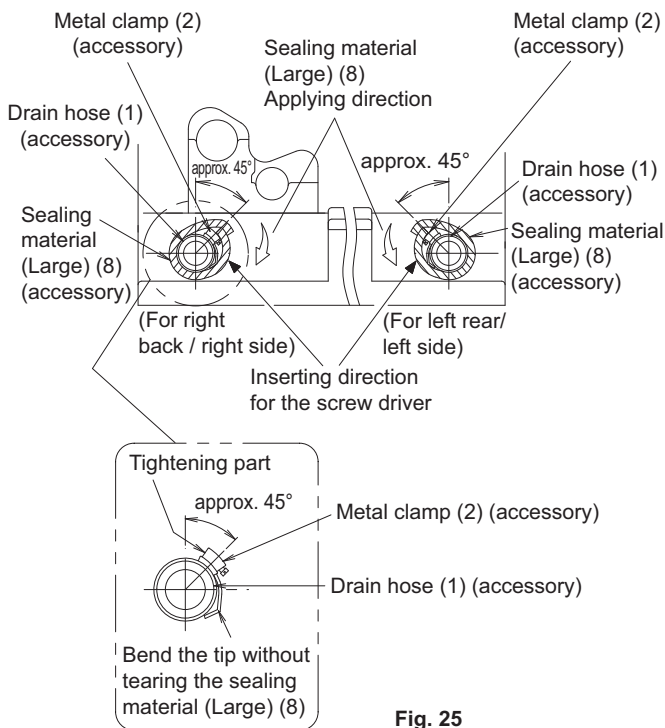

Fig. 25

- Be sure to insulate all drain piping running indoors.
- Do not deflect the drain hose (1) inside of the indoor unit. (Refer to Fig. 26)
(It may cause abnormal noise such as bubbling noise.)
(If the drain hose (1) is deflected, it may damage the suction grille.)

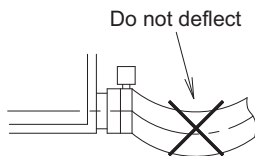

Fig. 26

- Install supports at a distance of 1 to 1.5m so that the piping may not deflect. (Refer to Fig. 22)

CAUTION

To prevent dust from entering the indoor unit, cover the gap with the drain piping by putty or insulation (field supply) so that no clearance is made.

However, when putting piping and remote controller wiring through the same hole, cover the gap between the through cover and the piping after "8. ELECTRIC WIRING WORK" is completed.

CAUTION

To avoid the attached drain hose (1) getting excessive force, do not bend nor twist it. (It may cause water leakage.) When conducting the centralized drain piping, follow the instructions in Fig. 27. For the diameter of the centralized drain piping, select the diameter matching the capacity of the indoor unit to be connected. (Refer to technical guidebook.)

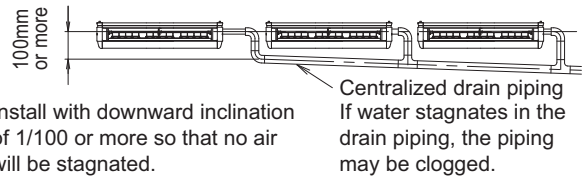

Fig. 27

- Connecting drain piping.
Do not connect the drain piping directly to the sewage that gives off ammonia odor. The ammonia in the sewage may go through the drain piping and corrode the heat exchanger of the indoor unit.
- When installing the drain pump kit (optional accessory), also refer to the installation manual included to the drain pump kit.

- (2) After piping is finished, check if the drain flows smoothly.
 - Gradually put about 0.6 liter of water for drain confirmation into the drain pan from the air outlet. (Refer to Fig. 28)

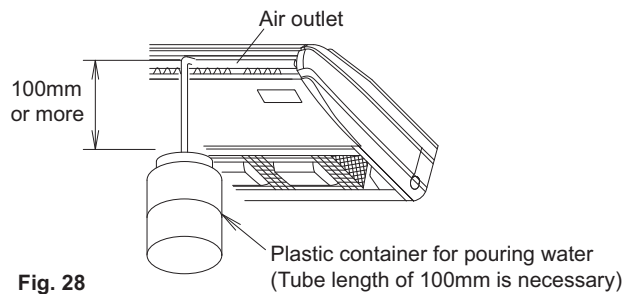

Fig. 28

- After the drain piping work, install the stay for packing and delivering (reinforcing plate), which was removed in the section of "6. REFRIGERANT PIPING WORK". However, it is not necessary to install the stay for packing and delivering at the right side (reinforcing plate). (Refer to Fig. 29)

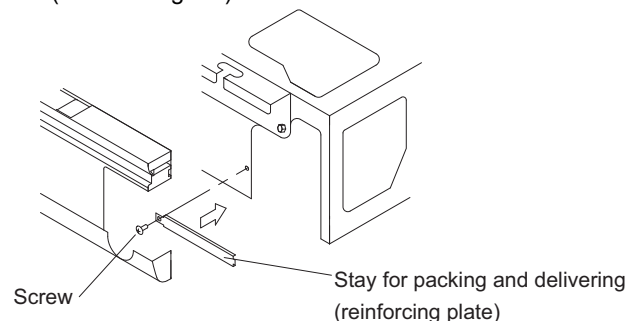

Fig. 29

8. ELECTRIC WIRING WORK

8-1 GENERAL INSTRUCTIONS

- Make certain that all electric wiring work is carried out by qualified personnel according to the applicable legislation and this installation manual, using a separate circuit. Insufficient capacity of the power supply circuit or improper electrical construction may lead to electric shocks or a fire.
- Make sure to install an earth leakage breaker in accordance with applicable legislation. Failure to do so may cause electrical shock and a fire.
- Do not turn on the power supply (of the indoor unit) until all the installation work is completed.
- Make sure to earth the air conditioner.
Earthing resistance should be according to applicable legislation.
- Do not connect the earth wiring to gas or water piping, lightning conductor or telephone earth wiring.
 - Gas piping Ignition or explosion may occur if the gas leaks.
 - Water piping Hard vinyl tubes are not effective earths.
 - Lightning conductor or telephone earth wiring
Electric potential may rise abnormally if struck by a lightning bolt.
- For electric wiring work, refer to also the "WIRING DIAGRAM" attached to the control box cover.
- Never connect the power supply wiring to the terminal block for remote controller wiring, or otherwise the entire system may be damaged.
- Carry out installation and wiring of the remote controller according to the "installation manual" attached to the remote controller.
- Do not touch the Printed Circuit Board assy during the wiring work. Otherwise, it may cause damage.
- If the supply cord is damaged, it must be replaced by the manufacturer, its service agent or similarly qualified persons in order to avoid a hazard.

8-2 SPECIFICATIONS FOR FIELD WIRING

For the wiring of outdoor units, refer to the installation manual attached to the outdoor units.

- Remote controller and transmission wiring are field supply. (Refer to Table 2)

Table 2

Component	Specification
Transmission wiring (NOTE 1.)	4-core cable 1.5 mm ² ~2.5 mm ² and applicable for 220~240 V H05RN-F (60245 IEC 57)
Remote controller wiring (NOTE 2.)	Vinyl cords with 0.75 to 1.25 mm ² sheath or cables (2-core wires) Maximum 500 m* H03VV-F (60227 IEC 52)

* This will be the total extended length in the system when doing group control.

Wiring specifications are shown on the condition that the wiring has a voltage drop of 2%.

NOTE

1. It shows the case when conduit piping are used. When the conduit piping are not used, use H07RN-F (60245 IEC 66).
2. Sheathed vinyl cord or cable (insulation thickness: 1mm or more)

9. HOW TO CONNECT WIRINGS AND WIRING EXAMPLE

Wiring connection method

Caution for wiring

- The indoor units in the same system can be connected to the power supply from one branch switch. However, selection of branch switch, branch overcurrent circuit breaker and wiring size must be according to applicable legislation.
- For connection to the terminal block, use ring type crimp style terminals with insulation sleeve or treat the wiring with insulation. (Refer to Fig. 30)

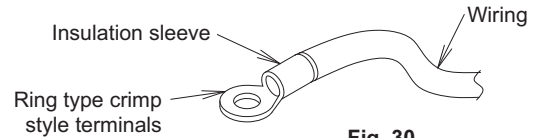

- If the above is not available, make sure to observe the following items.
- 2 wirings of different sizes to the terminal block for power supply is prohibited.

Connection of 2 wirings of same size must be carried out on both sides.

Connection of 2 wirings on one side is prohibited.

Connection of wirings of different sizes is prohibited.

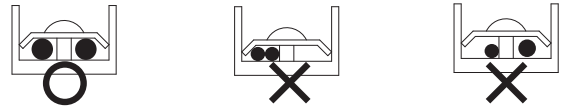

(Abnormal heating may occur if the wirings are not tightened securely.)

- Use the required wirings, connect them securely and fix these wirings so that external force may not apply to the terminals.
- Use a proper screw driver for tightening the terminal screws. If an improper screw driver is used, it may damage the screw head and a proper tightening cannot be carried out.
- If a terminal is over tightened, it may be damaged. Refer to the table shown below for tightening torque of terminals.

	Tightening torque (N·m)
Terminal block for remote controller and transmission wiring	0.88 ± 0.08
Terminal block for power supply	1.47 ± 0.14
Earth terminal	1.69 ± 0.25

- Conduct wiring so that the earth lead comes out from the notched part of the cup washer. (Otherwise, earth lead contact will be insufficient and grounding effect may be lost.)
- Do not carry out soldering finish when stranded wirings are used.

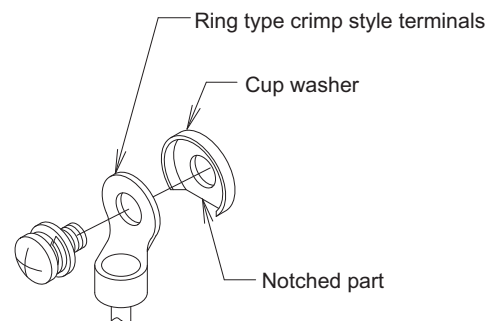

9-1 CONNECTION OF TRANSMISSION WIRING, EARTH WIRING AND FOR THE REMOTE CONTROLLER WIRING

- (1) Loosen the fixing screws (2 pcs.) while holding the control box cover, and then remove the control box cover.
- (2) Cut off the knockout hole and put the resin bushing (10) (accessory) on the back side (sheet metal).
- (3) Connect the transmission wiring through the resin bushing (10) accessory to the terminal block (X2M: 3P) while matching up the numbers (1 to 3), and then connect the earth wiring to the earth terminal.

After this is done, use the wiring fixture (11) and clamp (4) attached to bind the wiring without applying tension to the connecting section of the wirings.

- (4) Connect the remote controller wiring led from the routing hole to the terminals (P1 and P2) of the terminal block (X1M: 6P). (There is no polarity.)

After this is done, use the wiring fixture (11) and clamp (4) attached to bind the wiring without applying tension to the connecting section of the wirings.

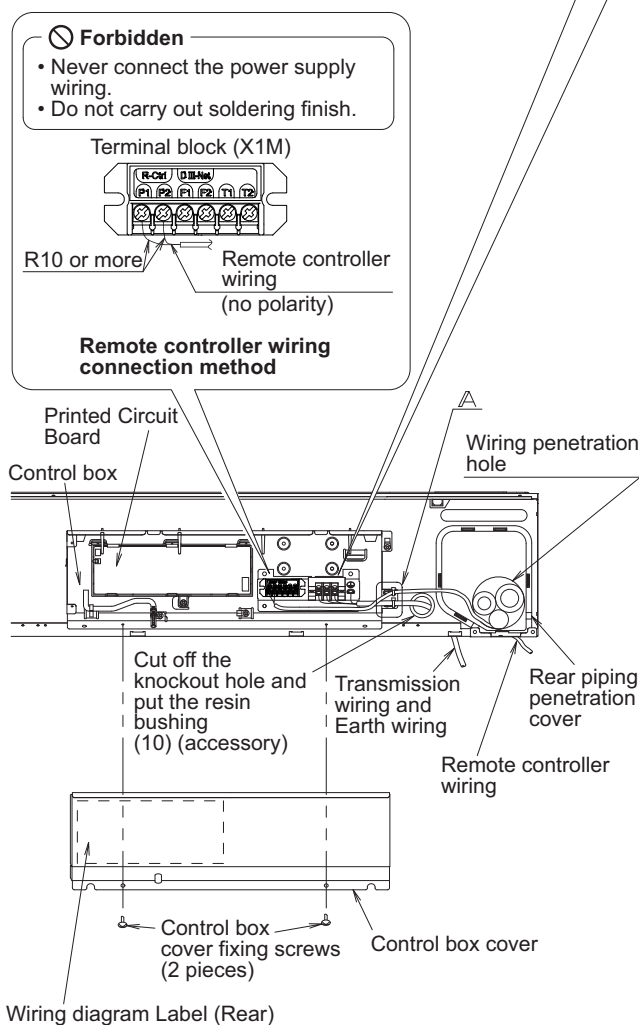
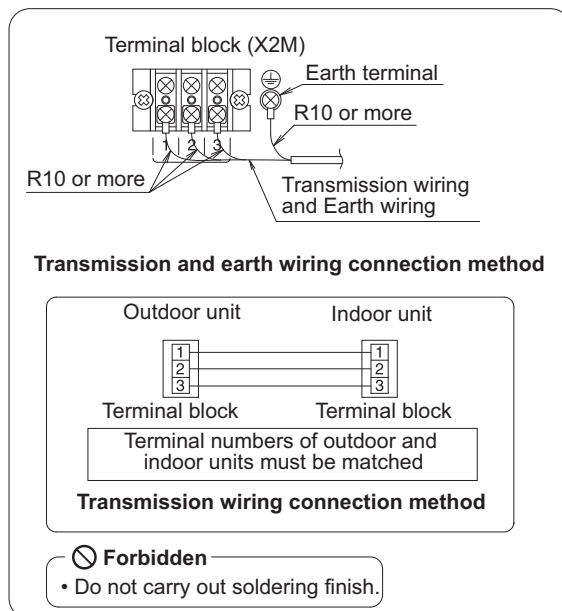

⚠ WARNING

When wiring, form the wirings orderly so that the control box cover can be securely fastened. If the control box cover is not in place, the wirings may float up or be sandwiched by the box and the panel and cause electric shocks or a fire.

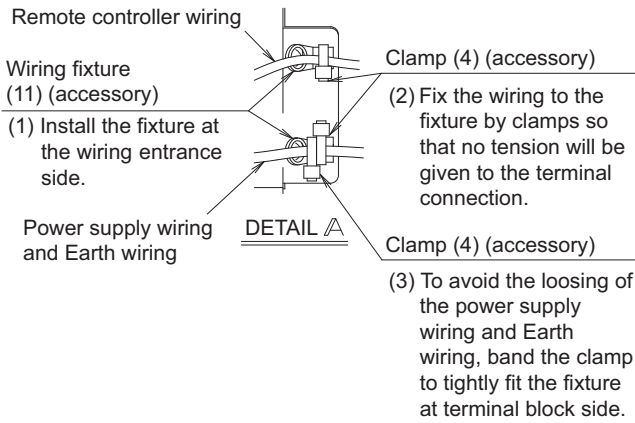

- In case the piping penetration cover is cut off and used as wiring penetration hole, after the wiring connection is finished, mend the cover.
- Seal the clearance around the wirings with putty and insulating material (field supply).
(If insects and small animals get into the indoor unit, short circuiting may occur inside the control box.)
- If the low voltage wiring (e. g. remote controller wiring) and the high voltage wiring (transmission wiring, earth wiring) are brought into the indoor unit from the same place, they may be affected by electric noise (outside noise) and cause malfunction or failure.
- Keep the distance of 50mm or more between the low voltage wiring (e. g. remote controller wiring) and the high voltage wiring (transmission wiring, earth wiring) anywhere outside the indoor unit. If both the wirings are laid down together, they may be affected by electric noise (outside noise) and cause malfunction or failure.

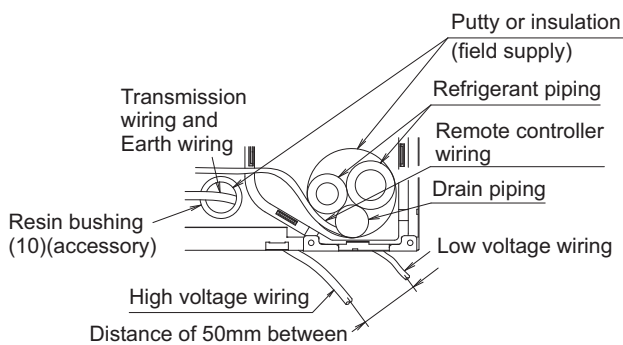

9-2 WIRING EXAMPLE

⚠ CAUTION

Be sure to install an earth leakage breaker to the outdoor unit.
This is to avoid electric shocks or a fire.

For the wiring of outdoor units, refer to the installation manual attached to the outdoor units. Confirm the system type.

- **Pair type:**
1 remote controller controls 1 indoor unit (standard system). (Refer to Fig. 31)
- **Simultaneous operation system:**
1 remote controller controls 2 indoor units (2 indoor units operates equally). (Refer to Fig. 32)
- **Group control:**
1 remote controller controls up to 16 indoor units (All indoor units operate according to the remote controller). (Refer to Fig. 33)
- **2 remote controllers control:**
2 remote controllers control 1 indoor unit. (Refer to Fig. 36)

Pair type

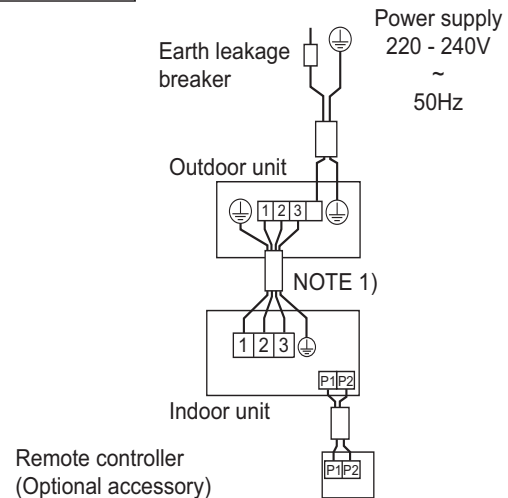

Fig. 31

Simultaneous operation system

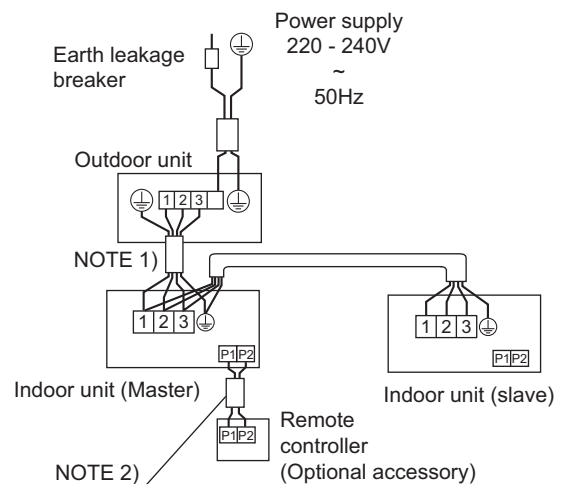
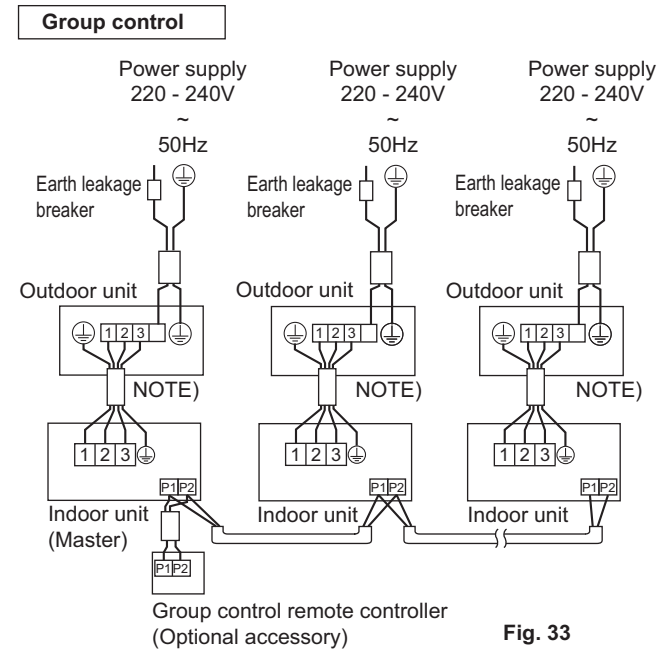

Fig. 32

NOTE 

1. Terminal numbers of outdoor and indoor units must be matched.
 - 2-1. Connect the remote controller only to the master unit.
 - 2-2. The remote controller needs to be wired only to the master unit; it does not need to be connected to the slave units through transition wiring. (Do not connect transition wiring to the slave units.)
 - 2-3. The indoor temperature sensor is effective only for indoor units to which the remote controller is connected.
 - 2-4. The length of wiring between the indoor unit and the outdoor unit varies depending on the connected model, the number of connected units, and the maximum piping length.
- For details, refer to the technical documents.



NOTE 

- Terminal numbers of outdoor and indoor units must be matched.
- When implementing group control**
- When using as a pair unit or as a master unit for simultaneous operation system, you may carry out simultaneous start/stop (group) control up to 16 units with the remote controller. (Refer to Fig. 34)
 - In this case, all the indoor units in the group will operate in accordance with the group control remote controller.
 - Select a remote controller which matches as many of the functions (airflow direction, etc.) in the group as possible.

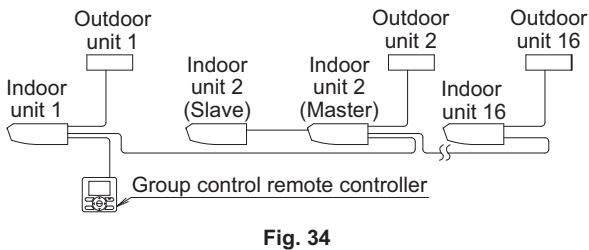

Wiring Method

- (1) Remove the control box cover. (Refer to "9. HOW TO CONNECT WIRINGS AND WIRING EXAMPLE".)

- (2) Connect crossover wiring between the terminals (P1, P2) inside the control box for the remote controller. (There is no polarity.) (Refer to Fig. 34 and Table 3)

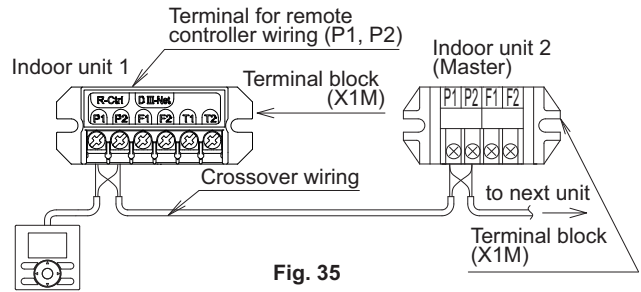

Control with 2 remote controllers control

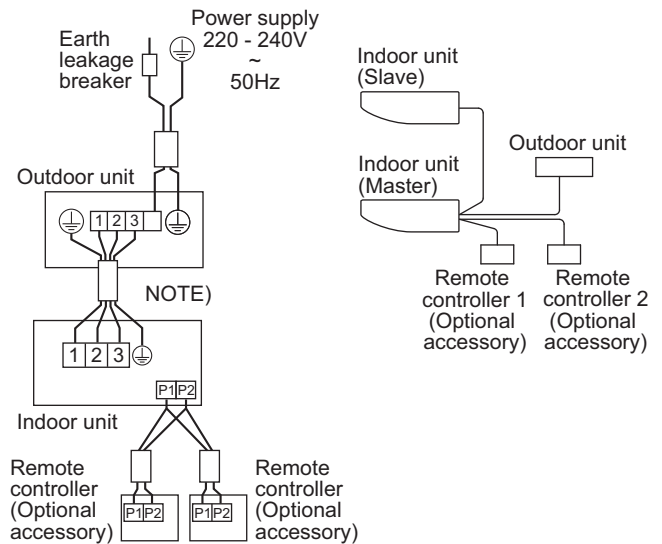

Two remote controllers control (Controlling 1 indoor unit by 2 remote controllers)

- When using 2 remote controllers, one must be set to "MAIN" and the other to "SUB".

MAIN/SUB CHANGEOVER

- Refer to the manual attached to the remote controller.

Wiring Method

- (1) Remove the control box cover.
- (2) Add wiring between the remote controller 2 (Sub) and the terminal (P1, P2) of the terminal block (X1M) for the remote controller in the control box. (There is no polarity.)

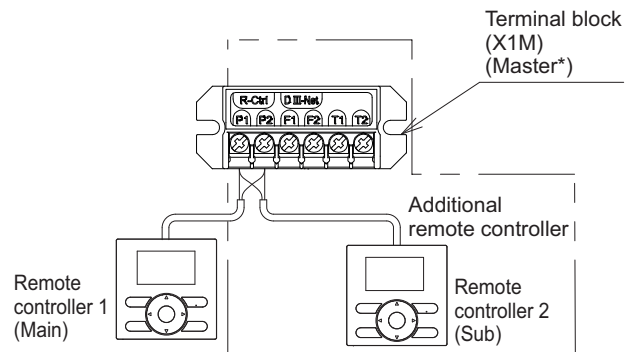

* For simultaneous operation system, be sure to connect the remote controller to the master unit.

NOTE 

- Terminal numbers of outdoor and indoor units must be matched.

10. MOUNTING SUCTION GRILLE · DECORATION SIDE PANEL

Install securely in the reverse order when decoration side panel and suction grille were removed.

- When installing the suction grille, hang the string of the suction grille to the hanging part of the indoor unit shown Fig. 38.

⚠ CAUTION

When closing the suction grille, the strap may get caught. Confirm that the strap does not stick out of the side of the suction grille before closing.

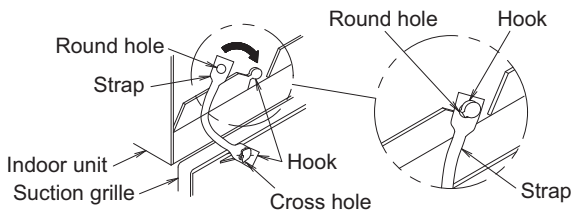

Fig. 38

11. FIELD SETTING

<<Refer to also the installation manual attached to the outdoor unit.>>

⚠ CAUTION

Before carrying out field setting, check the items mentioned in the clause 2 "Items to be checked after the installation work is completed" on page 3.

- Check if all the installation and piping works for the air conditioner are completed.
- Check if the control box cover of air conditioner is closed.

<FIELD SETTING>

<After turn on the power supply, carry out field setting from the remote controller according to the installation state.>

- Carry out setting at 3 places, "Mode No.", "FIRST CODE No." and "SECOND CODE No."

The settings shown by " " in the table indicate those when shipped from the factory.

- The method of setting procedure and operation is shown in the installation manual attached to the remote controller. (Note) Though setting of "Mode No." is carried out as a group, if you intend to carry out individual setting by each indoor unit or confirmation after setting, carry out setting with the "Mode No." shown in the parenthesis ().

- In case of remote control, for changeover of input to FORCED OFF or to ON/OFF OPERATION.

[1] Enter into the field setting mode with the remote controller.

[2] Select Mode No. "12".

[3] Set the FIRST CODE No. to "1".

[4-1] For FORCE OFF, set the SECOND CODE No. to "01".

[4-2] For ON/OFF OPERATION, set the SECOND CODE No. to "02".

(It is set to FORCED OFF when shipped from the factory.)

- Ask your customer to keep the manual attached to the remote controller together with the operation manual.
- Do not carry out setting other than those shown in the table.

11-1 SETTING WHEN AN OPTIONAL ACCESSORY IS ATTACHED

- For setting when attaching an optional accessory, refer to the installation manual attached to the optional accessory.

11-2 WHEN USING WIRELESS REMOTE CONTROLLER

- When using a wireless remote controller, it is necessary to set the wireless remote controller address. Refer to the installation manual attached to the wireless remote controller.

11-3 SETTING CEILING HEIGHT (CLASS 100 OR LESS)

- When installing indoor unit class 35 - 100, specify the SECOND CODE No. in accordance with the ceiling height.

Table 3

	Ceiling height (m)			Mode No.	FIRST CODE No.	SECOND CODE No.
	Class 35,50	Class 60,71	Class 100			
Standard	2.7 or less	2.7 or less	3.8 or less	13 (23)	0	01
High ceiling	2.7 - 3.5	2.7 - 3.5	3.8 - 4.3			02

11-4 SETTING FILTER SIGN

- A message to inform the air filter cleaning time will be indicated on the remote controller.
- Set the SECOND CODE No. shown in the Table 5 according to the amount of dust or pollution in the room.
- Though the indoor unit is equipped with the long life filter, it is necessary to periodically clean the filter to avoid clogging of the filter. Please also explain the set time to the customer.
- The periodical filter cleaning time can be shortened depending on the environment.

Table 4

Contamination	Filter hours (long life type)	Mode No.	FIRST CODE No.	SECOND CODE No.
Normal	Approx. 2500 hrs	10 (20)	0	01
More contaminated	Approx. 1250 hrs			02
With indication			3	01
No indication				02

* Use "No indication" setting when cleaning indication is not necessary such as the case of periodical cleaning being carried out.

11-5 SETTING FAN SPEED DURING THERMOSTAT OFF

- Set the fan speed according to the using environment after consultation with your customer.

Table 5

Setting		Mode No.	FIRST CODE No.	SECOND CODE No.
Fan operates / stops during thermo OFF (Cooling · heating)	Operates	11 (21)	2	01
	Stops			02
Fan speed during cooling thermostat OFF	(Extra low)	12 (22)	6	01
	Setting			02
Fan speed during heating thermostat OFF	(Extra low)	12 (22)	3	01
	Setting			02

11-6 SETTING NUMBER OF THE CONNECTED INDOOR UNITS AS SIMULTANEOUS OPERATION SYSTEM

- When using in simultaneous operation system mode, change the SECOND CODE No. as shown in Table 6.
- When using in simultaneous operation system mode, refer to "SIMULTANEOUS OPERATION SYSTEM INDIVIDUAL SETTING" section to set master and slave units separately.

Table 6

Setting	Mode No.	FIRST CODE No.	SECOND CODE No.
Pair system (1 unit)	11 (21)	0	01
Simultaneous operation system (2-unit)			02
Simultaneous operation system (3-unit)			03
Double twin multi (4-unit)			04

11-7 SIMULTANEOUS OPERATION SYSTEM INDIVIDUAL SETTING

It is easier if the optional remote controller is used when setting the slave unit.

< Procedure >

- Perform the following procedure when setting the master and slave unit separately.
- "□" in the tables indicates factory settings.
(Note) The "Mode No." is set on a group basis. To individually set a Mode No. for each indoor unit or confirm the settings, set the Mode No. in the parenthesis.

(1) Change the SECOND CODE No. to "02", individual setting, so that the slave unit can be individually set.

Table 7

Setting	Mode No.	FIRST CODE No.	SECOND CODE No.
Unified setting	11 (21)	1	01
Individual setting			02

- Perform field setting (Refer to 11-1 to 11-5) for the master unit.
- Turn off the main power supply switch after (2) is finished.
- Detach remote controller from the master unit and connect it to the slave unit.
- Turn on the main power supply switch again, and as in (1), change the SECOND CODE No. to "02", individual setting.
- Perform field setting (Refer to 11-1 to 11-4) for the slave unit.
- Turn off the main power supply switch after (6) is finished.
- If there is more than one slave unit, repeat steps (4) to (7).
- Detach the remote controller from the slave unit after the setting, and reattach to the master unit. This is the end of the setting procedure.

* You do not need to rewire the remote controller from the master unit if the optional remote controller for slave unit is used. (However, remove the wiring attached to the remote controller terminal block of the master unit.) After the slave unit setting, remove the remote controller wiring, and rewire the remote controller to the master unit. (The indoor unit does not operate properly when two or more remote controllers are attached to the unit in the simultaneous operation system mode.)

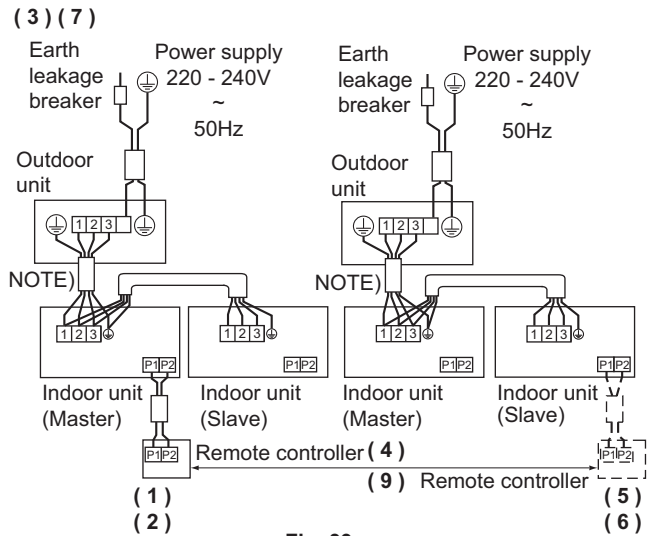

Fig. 39

NOTE

- Terminal numbers of outdoor and indoor units must be matched.

12. TO PERFORM A TEST RUN

CAUTION

This task is only applicable when using the BRC1E52 or BRC1E53 user interface. When using any other user interface, see the installation manual or service manual of the user interface.

NOTE

- Backlight.** To perform an ON/OFF action on the user interface, the backlight does not need to be lit. For any other action, it needs to be lit first. The backlight is lit for ±30 seconds when you press a button.

- Perform introductory steps.

Table 8

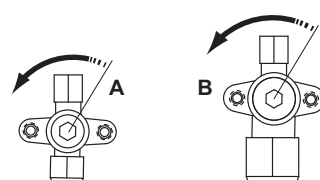
#	Action
1	Open the liquid stop valve (A) and gas stop valve (B) by removing the stem cap and turning counterclockwise with a hex wrench until it stops. 
2	Close the service cover to prevent electric shocks.
3	Turn On power for at least 6 hours before starting operation to protect the compressor.
4	On the user interface, set the unit to cooling operation mode.

2. Start the test run.

Table 9

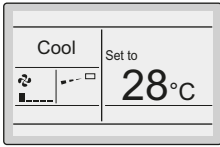
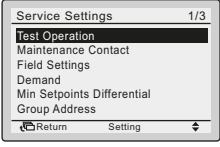
#	Action	Result
1	Go to the home menu	
2	Press at least 4 seconds.	The Service Setting menu is displayed.
3	Select the Test Operation.	
4	Press.	Test Operation is displayed on the home menu.
5	Press within 10 seconds.	Test run starts.

3. Check operation for 3 minutes.

4. Check operation of the airflow direction.

Table 10

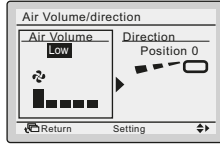
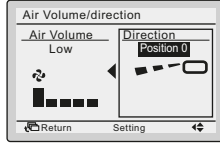
#	Action	Result
1	Press.	
2	Select Position 0.	
3	Change the position.	If the airflow flap of the indoor unit moves, operation is OK. If not, operation is not OK.
4	Press.	The home menu is displayed.

5. Stop the test run.

Table 11

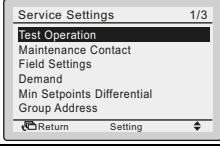
#	Action	Result
1	Press at least 4 seconds.	The Service Settings menu is displayed.
2	Select Test Operation.	
3	Press.	The unit returns to normal operation, and the home menu is displayed.

12-1 ERROR CODES WHEN PERFORMING A TEST RUN

If the installation of the outdoor unit has NOT been done correctly, the following error codes may be displayed on the user interface:

Error code	Possible cause
Nothing displayed (The currently set temperature is not displayed)	<ul style="list-style-type: none"> The wiring is disconnected or there is a wiring error (between power supply and outdoor unit, between outdoor unit and indoor units, between indoor unit and remote controller) The fuse on the outdoor unit PCB has blown out.
E3, E4 or L8	<ul style="list-style-type: none"> The stop valves are closed. The air inlet or air outlet is blocked.
E7	<ul style="list-style-type: none"> There is a missing phase in case of three-phase power supply units. Note: Operation will be impossible. Turn OFF the power, recheck the wiring, and switch two of the three electrical wires.
L4	The air inlet or air outlet is blocked.
U0	The stop valves are closed.
U2	<ul style="list-style-type: none"> There is a voltage imbalance. There is a missing phase in case of three-phase power supply units. Note: Operation will be impossible. Turn OFF the power, recheck the wiring, and switch two of the three electrical wires.
U4 or UF	The inter-unit branch wiring is not correct.
UA	The outdoor and indoor unit are incompatible.

⚠ CAUTION

After test operation is completed, check the items mentioned in the clause 2 "Items to be checked after the installation work is completed" on page 3.

If the interior finish work is not completed when the test operation is finished, for protection of the air conditioner, ask the customer not operate the air conditioner until the interior finish work is completed.















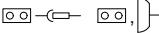

If the air conditioner is operated, the inside of the indoor units may be polluted by substances generated from the coating and adhesives used for the interior finish work and cause water splash and leakage.

⚠ To the operator carrying out test operation

After test operation is completed, before delivering the air conditioner to the customer, confirm that the control box cover is closed.

In addition, explain the power supply status (power supply ON/OFF) to the customer.

13. UNIFIED WIRING DIAGRAM LEGEND

Unified Wiring Diagram Legend					
For applied parts and numbering, refer to the wiring diagram on the unit. Part numbering is by Arabic numbers in ascending order for each part and is represented in the overview below by symbol "*" in the part code.					
	:	CIRCUIT BREAKER		:	PROTECTIVE EARTH
	:	CONNECTION		:	PROTECTIVE EARTH (SCREW)
	:	CONNECTOR		:	RECTIFIER
	:	EARTH		:	RELAY CONNECTOR
	:	FIELD WIRING		:	SHORT-CIRCUIT CONNECTOR
	:	FUSE		:	TERMINAL
	:	INDOOR UNIT		:	TERMINAL STRIP
	:	OUTDOOR UNIT		:	WIRE CLAMP
BLK	:	BLACK	GRN	:	GREEN
BLU	:	BLUE	GRY	:	GREY
BRN	:	BROWN	PNK	:	PINK
			PRP, PPL	:	PURPLE
			RED	:	RED
			WHT	:	WHITE
			YLN	:	YELLOW
A*P	:	PRINTED CIRCUIT BOARD	PS	:	SWITCHING POWER SUPPLY
BS*	:	PUSHBUTTON ON/OFF, OPERATION SWITCH	PTC*	:	THERMISTOR PTC
BZ, H*O	:	BUZZER	Q*	:	INSULATED GATE BIPOLAR TRANSISTOR (IGBT)
C*	:	CAPACITOR	Q*DI	:	EARTH LEAK CIRCUIT BREAKER
AC*, CN*, E*, HA*, HE*, HL*, HN*, HR*, MR*_A, MR*_B, S*, U, V, W, X*A, K*R_*	:	CONNECTION, CONNECTOR	Q*L	:	OVERLOAD PROTECTOR
D*, V*D	:	DIODE	Q*M	:	THERMO SWITCH
DB*	:	DIODE BRIDGE	R*	:	RESISTOR
DS*	:	DIP SWITCH	R*T	:	THERMISTOR
E*H	:	HEATER	RC	:	RECEIVER
F*U, FU* (FOR CHARACTERISTICS, REFER TO PCB INSIDE YOUR UNIT)	:	FUSE	S*C	:	LIMIT SWITCH
FG*	:	CONNECTOR (FRAME GROUND)	S*L	:	FLOAT SWITCH
H*	:	HARNESS	S*NPH	:	PRESSURE SENSOR (HIGH)
H*P, LED*, V*L	:	PILOT LAMP, LIGHT EMITTING DIODE	S*NPL	:	PRESSURE SENSOR (LOW)
HAP	:	LIGHT EMITTING DIODE (SERVICE MONITOR GREEN)	S*PH, HPS*	:	PRESSURE SWITCH (HIGH)
HIGH VOLTAGE	:	HIGH VOLTAGE	S*PL	:	PRESSURE SWITCH (LOW)
IES	:	INTELLIGENT EYE SENSOR	S*T	:	THERMOSTAT
IPM*	:	INTELLIGENT POWER MODULE	S*RH	:	HUMIDITY SENSOR
K*R, KCR, KFR, KHuR, K*M	:	MAGNETIC RELAY	S*W, SW*	:	OPERATION SWITCH
L	:	LIVE	SA*, F1S	:	SURGE ARRESTOR
L*	:	COIL	SR*, WLU	:	SIGNAL RECEIVER
L*R	:	REACTOR	SS*	:	SELECTOR SWITCH
M*	:	STEPPER MOTOR	SHEET METAL	:	TERMINAL STRIP FIXED PLATE
M*C	:	COMPRESSOR MOTOR	T*R	:	TRANSFORMER
M*F	:	FAN MOTOR	TC, TRC	:	TRANSMITTER
M*P	:	DRAIN PUMP MOTOR	V*, R*V	:	VARISTOR
M*S	:	SWING MOTOR	V*R	:	DIODE BRIDGE
MR*, MRCW*, MRM*, MRN*	:	MAGNETIC RELAY	WRC	:	WIRELESS REMOTE CONTROLLER
N	:	NEUTRAL	X*	:	TERMINAL
n=*, N=*	:	NUMBER OF PASSES THROUGH FERRITE CORE	X*M	:	TERMINAL STRIP (BLOCK)
PAM	:	PULSE-AMPLITUDE MODULATION	Y*E	:	ELECTRONIC EXPANSION VALVE COIL
PCB*	:	PRINTED CIRCUIT BOARD	Y*R, Y*S	:	REVERSING SOLENOID VALVE COIL
PM*	:	POWER MODULE	Z*C	:	FERRITE CORE
			ZF, Z*F	:	NOISE FILTER

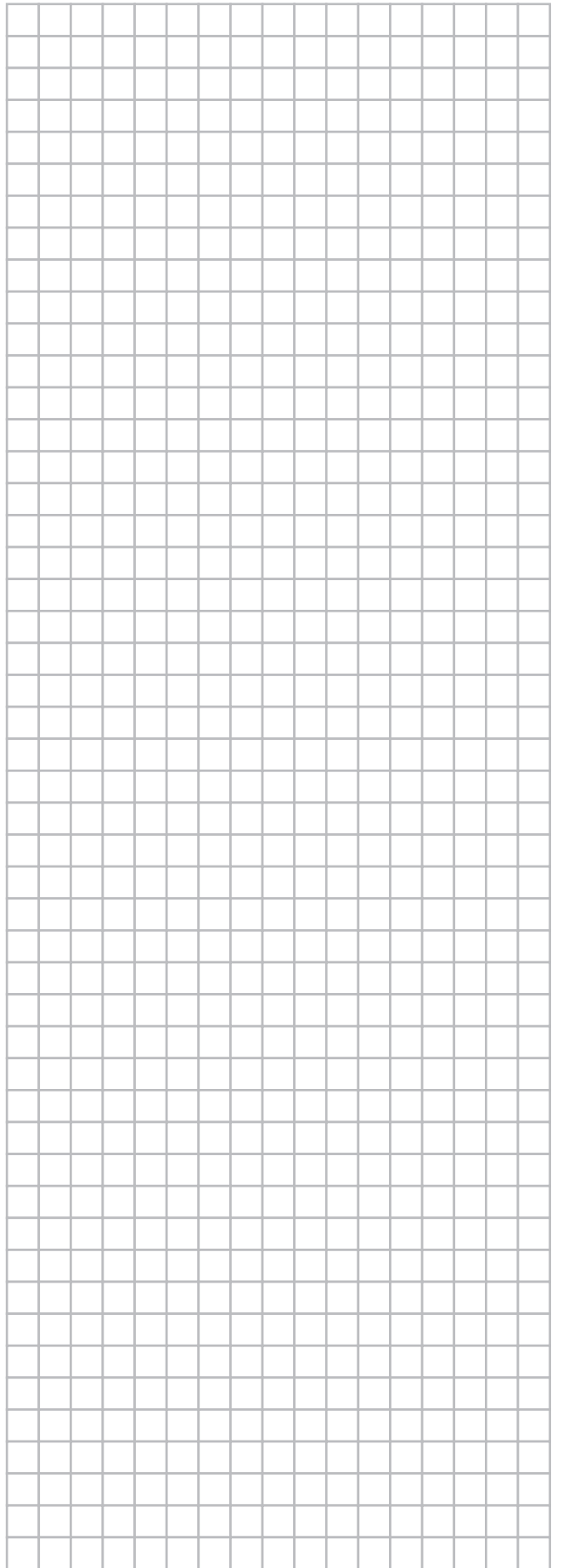
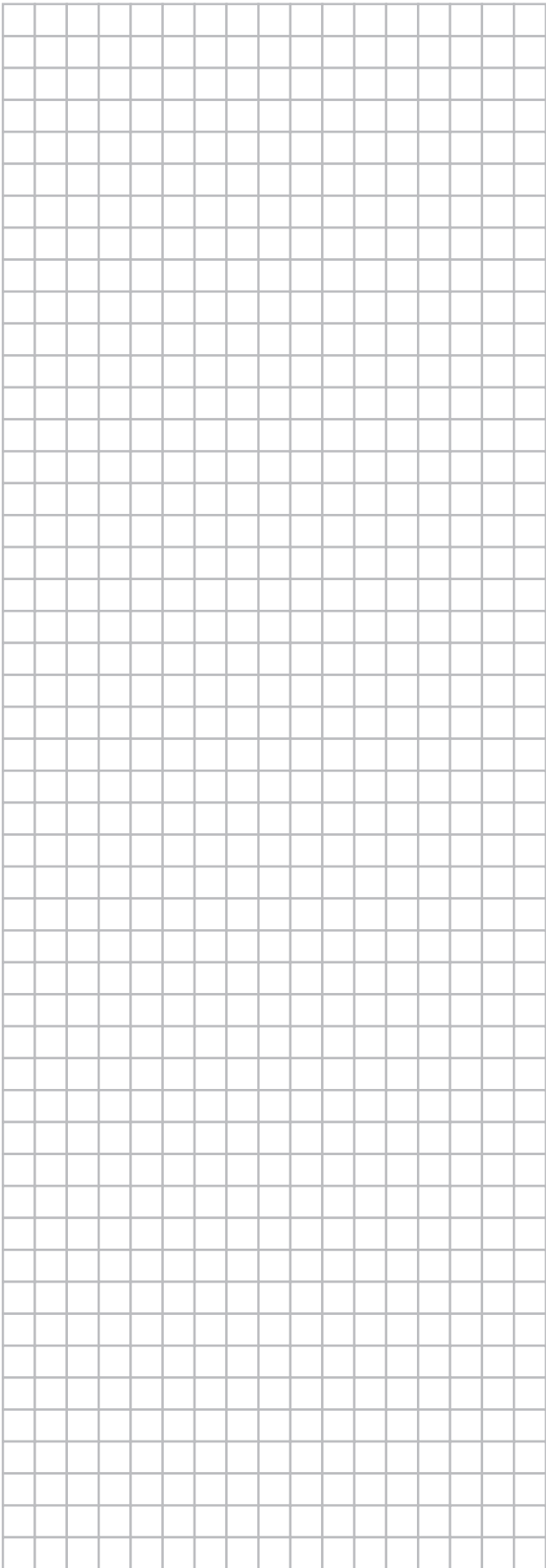

DAIKIN EUROPE N.V.

Zandvoordestraat 300, B-8400 Oostende, Belgium

Copyright 2017 Daikin

